

The WE series of Gefran, are pressure transmitters for using in High temperature environment.

The main characteristic of this series is the capability to read temperature of the media up to 315°C.

The constructive principle is based on the hydraulic transmission of the pressure.

The fluid-filled system assures the temperature stability. The physical measure is transformed in a electrical measure by means the strain-gauge technology.

MAIN FEATURES

- Pressure ranges from:
0-35 to 0-1000 bar / 0-500 to 0-15000 psi
- Accuracy: $< \pm 0.25\%$ FSO (H); $< \pm 0.5\%$ FSO (M)
- Fluid-filled system for temperature stability
- Oil filling meets FDA requirements CFR 178.3620 and CFR 172.878
- Oil filling volume:
WE0 (30mm³); WE1, WE2, WE3 (40mm³)
- 1/2-20UNF, M18x1.5 standard threads; other types available on request
- Other diaphragms available on request
- Autozero function on board / external option
- Drift Autocompensation function (SP version)
- 17-7 PH corrugated diaphragm with GTP coating for ranges below 100 bar-1500 psi

GTP (advanced protection)

Coating with high resistance against corrosion, abrasion and high temperature

AUTOZERO FUNCTION

All signal variations in the absence of pressure can be eliminated by using the Autozero function.

This function is activated by closing a magnetic contact located on the transmitter housing.

The procedure is permitted only with pressure at zero.

AUTOCOMPENSATES INFLUENCE OF MELT TEMPERATURE

Thanks to internal self-compensation, the WSP series transmitter cancels the effect of pressure signal variation caused by variation of Melt temperature.

This reduces at the minimum the read error caused by heating of the filling fluid (typical of all sensors built with "filled" technology).

TECHNICAL SPECIFICATIONS

Accuracy (1)	H $< \pm 0.25\%$ FSO (100...1000 bar) M $< \pm 0.5\%$ FSO (35...1000 bar)
Resolution	Infinite
Measurement range	0..35 to 0..1000bar 0..500 to 0..15000psi
Maximum overpressure (without degrading performances)	2 x FS 1.5 x FS above 500bar/7500psi
Measurement principle	Extensimetric
Power supply	10...30Vdc
Maximum current absorption	32mA
Insulation resistance (at 50Vdc)	>1000 MOhm
Output signal Full Scale (FSO)	20mA
Zero balance (tolerance $\pm 0.25\%$ FSO)	4mA
Zero signals adjustment (tolerance $\pm 0.25\%$ FSO)	"Autozero" function
Span adjustment within $\pm 5\%$ FSO	See Manual
Maximum allowed load	See diagram
Response time (10...90% FSO)	~ 1ms
Output noise (RMS 10-400Hz)	< 0.025% FSO
Calibration signal	80% FSO
Output short circuit ingress and reverse polarity protection	YES
Compensated temperature range	0...+85°C
Operating temperature range	-30...+105°C
Storage temperature range	-40...+125°C
Thermal drift in compensated range: Zero / Calibration / Sensibility	< 0.02% FSO/°C
Diaphragm maximum temperature	315°C / 600°F
Zero drift due to change in process temperature (zero)	< 0.04 bar/°C
Zero drift temperature for Autocompensated version (SP) within the temperature range 20°C-315°C inclusive the drift temperature of the housing	< 0.005 bar/°C 100 ≤ p < 500 bar 0.0022 %FS/°C p ≥ 500 bar
Standard Material in contact with process medium	Diaphragm: • 17-7PH corrugated diaphragm with GTP Stem • 17-4 PH
Thermocouple (model WE2)	STD: type "J" (isolated junction)
Protection degree (with 6-pole female connector)	IP65

FSO = Full scale output

(1) BFSL method (Best Fit Straight Line): includes combined effects of Non-Linearity, Hysteresis and Repeatability.

MECHANICAL DIMENSIONS

WE0

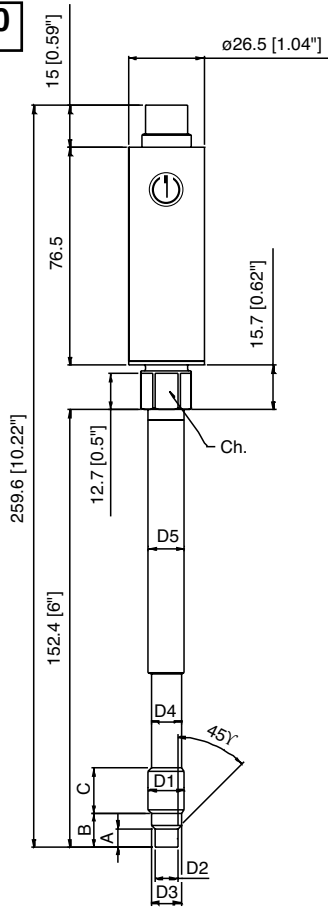

D1	1/2 - 20UNF
D2	$\phi 7.8 -0.05$ [$\phi 0.31$ " -0.002]
D3	$\phi 10.5 -0.025$ [$\phi 0.41$ " -0.001]
D4	$\phi 10.67$ [$\phi 0.42$ "]
D5	$\phi 12.7$ [$\phi 0.5$ "]
A	$5.56 -0.26$ [0.22 " -0.01]
B	11.2 [0.44 "]
C	15.74 [0.62 "]
Ch	16
[Hex]	[$5/8$ "]

WE2

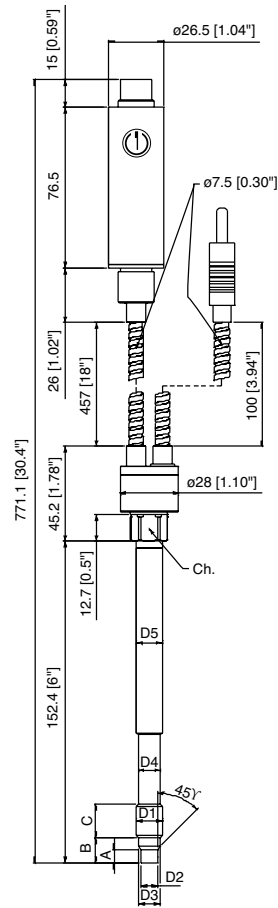

WE1

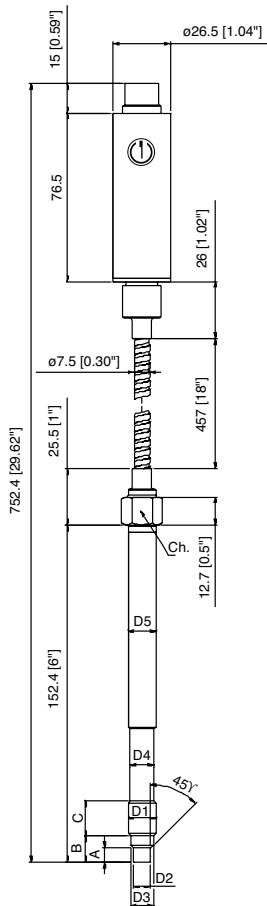

D1	M18x1.5
D2	$\phi 10 -0.05$ [$\phi 0.394$ " -0.002]
D3	$\phi 16 -0.08$ [$\phi 0.63$ " -0.003]
D4	$\phi 16 -0.4$ [$\phi 0.63$ " -0.016]
D5	$\phi 18$ [$\phi 0.71$ "]
A	$6 -0.26$ [0.24 " -0.01]
B	$14.8 -0.4$ [0.58 " -0.016]
C	19 [0.75 "]
Ch	19
[Hex]	[$3/4$ "]

WE3

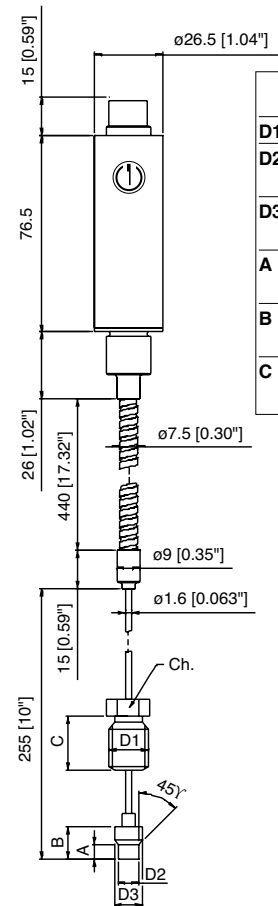

Exposed capillary	
D1	1/2-20UNF
D2	.307/.305" [7.80/7.75mm]
D3	.414/.412" [10.52/10.46mm]
A	.125/.120" [3.18/3.05mm]
B	.318/.312" [8.08/7.92mm]
C	.81" [20.6mm]

NOTE : dimensions refer to rigid stem length option "4" (153 mm – 6")

WARNING : For installation use a maximum tightening torque of 56 Nm(500 in-lb)

ELECTRICAL CONNECTIONS

CURRENT OUTPUT (4...20mA, two wires)

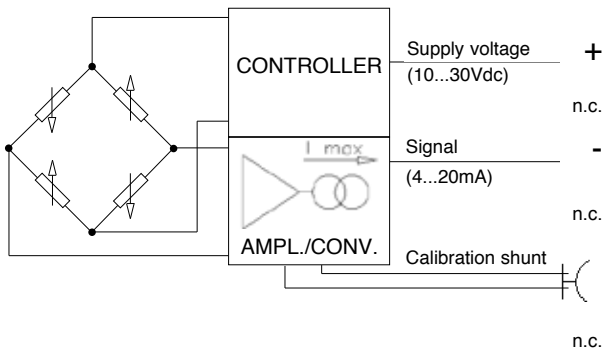

6 pin connector
VPT07RA10-6PT2
(PT02A-10-6P)

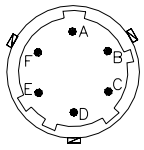

8 pin connector
PC02E-12-8P Bendix

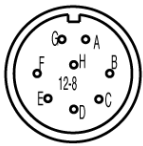

MAGNETIC AUTOZERO

6-pin	8-pin
A	B
C	A
B	D
D	C
E - F	E - F
	G - H

Shield drain wire is tied to connector via cable clamp

EXTERNAL AUTOZERO

6-pin	8-pin
A	B
C	A
B	D
D	C
E - F	E - F
	G - H

LOAD DIAGRAM

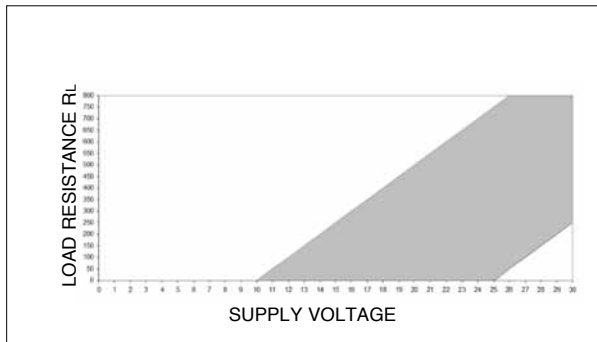

The diagram shows the optimum ratio between the load and supply voltage of the 4...20mA transmitter. For a correct use, choose any combination of load resistance and supply voltage, in the shaded area.

AUTOZERO FUNCTION

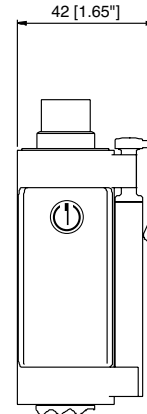

The Autozero function is activated through a magnetic contact (external magnet supplied with the sensor). See the manual for a complete Autozero function explanation.

ACCESSORIES

Connectors

6-pin mating connector (IP65 protection degree)
8-pin mating connector

Extension cables

6-pin connector with 8m (25ft) cable
6-pin connector with 15m (50ft) cable
6-pin connector with 25m (75ft) cable
6-pin connector with 30m (100ft) cable

Other lengths

Accessories

Mounting bracket
Dummy plug for 1/2-20UNF
Dummy plug for M18x1.5
Drill kit for 1/2-20UNF
Drill kit for M18x1.5
Cleaning kit for 1/2-20UNF
Cleaning kit for M18x1.5
Fixing pen clip
Autozero pen

Thermocouple for WE2 model

Type "J" (153mm - 6" stem)

CON300
CON307

C08WLS
C15WLS
C25WLS
C30WLS

consult factory

SF18
SC12
SC18
KF12
KF18
CT12
CT18
PKIT309
PKIT312

TTER 601

Cable color code

Conn.	Wire
A	Red
B	Black
C	White
D	Green
E	Blue
F	Orange

ORDER CODE

W - □ - □ - □ - □ - □ - □ - □ - □ - □ - □ - □ - **000**

Autocompensation (*)	SP
Standard	-

(*) available for ranges > to 100bar
 (*) not available for WE3 version

OUTPUT SIGNAL	
4...20mA	E

CONFIGURATION	
Rigid stem	0
Rigid stem + flexible	1
With thermocouple	2
Exposed capillary	3

CONNECTOR	
Standard	
6 pin	6
8 pin	8

ACCURACY CLASS	
0.25% FSO (ranges ≥ 100 bar/1500 psi)	H
0.5% FSO	M

RANGE			
bar		psi	
35	B35U	500	P05C
50	B05D	750	P75D
70	B07D	1000	P01M
100	B01C	1500	P15C
200	B02C	3000	P03M
350	B35D	5000	P05M
500	B05C	7500	P75C
700	B07C	10000	P10M
1000	B01M	15000	P15M

000= Standard version
 Special or customized versions available on request

E	External autozero
-	Magnetic autozero

FLEXIBLE LENGTH
 (mm / inches) (*)

Standard (WE0)

0	none
----------	------

Standard (WE1, WE2)

D	457mm	18"
----------	-------	-----

E	610mm	24"
----------	-------	-----

F	760mm	30"
----------	-------	-----

Standard (WE3)

L	711mm	28"
----------	-------	-----

Available on request

A	76mm	3"
----------	------	----

B	152mm	6"
----------	-------	----

C	300mm	12"
----------	-------	-----

RIGID STEM LENGTH
 (mm / inches) (*)

Standard (WE0, WE1, WE2)

4	153mm	6"
----------	-------	----

5	318mm	12.5"
----------	-------	-------

Standard (WE3)

0	none
----------	------

Available on request

1	38mm	1.5"
----------	------	------

2	50mm	2"
----------	------	----

3	76mm	3"
----------	------	----

6	350mm	14"
----------	-------	-----

7	400mm	16"
----------	-------	-----

8	456mm	18"
----------	-------	-----

(*) max combined stem/flexible length is 914mm - 36"

THREAD

Standard

1	1/2 - 20 UNF
----------	--------------

4	M18 x 1.5
----------	-----------

Examples

WE2-6-M-B07C-1-4-D-000

Melt pressure transmitter with type "J" thermocouple, 4...20mA output, 6-pin connector, 1/2-20UNF thread, 700 bar full scale, 0,5% accuracy class, 153 mm (6") rigid stem, 457mm (18") flexible capillary.

WSPM0-6-M-P03M-1-4-0-000

Melt pressure transmitter autocompensated version, rigid stem, 4...20mA output, 6-pin connector, 1/2-20UNF thread, 3000 psi full scale, 0,5% accuracy class, 153 mm (6") rigid stem.

Sensors are manufactured in compliance with:

- EMC 2004/108/CE compatibility directive
- RoHS 2002/95/CE directive

Electrical installation requirements and Conformity certificate are available on our web site: www.gefran.com

GEFRAN reserves the right to make any kind of design or functional modification at any moment without prior notice.

GEFRAN spa
 via Sebina, 74
 25050 PROVAGLIO D'ISEO (BS) - ITALIA
 tel. 0309888.1 - fax. 0309839063
 Internet: <http://www.gefran.com>

